

Study of deuterium charging behaviour in palladium and palladium alloy plates, changing surface treatments, by μs pulsed electrolysis.

Francesco CELANI*, Antonio SPALLONE*, Paolo TRIPODI*,
Alessandra PETROCCHI*, Daniele Di GIOACCHINO*
Paolo MARINI**, Vittorio Di STEFANO**
Marco DIOCIAIUTI***, Alfredo MANCINI****,

* INFN, Laboratori Nazionali di Frascati, via E.Fermi 40, 00044 Frascati (Italy).

**SKITEK, IRI, Pomezia (Italy)

***ISS, Via Regina Margherita 5, 00100 Roma (Italy)

****ORIM S.R.L., Via Concordia 65, 62100 Macerata (Italy)

(*)

Abstract

A systematic study about deuterium loading in palladium has been performed. Palladium cold worked plates and palladium alloy plates have been used as comparison. A proper plate surface oxidation has been performed and anomalous absorption rates have been measured. A high peak current (15 A), short width pulse (duration 1 μs) electrolysis technique has been used to test all cathode plates and it is visible that this technique permits to reach very high D/Pd loading values (around 1/1 or even more for palladium). At the beginning of the loading, in close relation with the anomalous absorption rate, a bump of excess heat has been measured in two similar oxidized surface palladium plates.

All these tests show that the loading is completely reproducible.

1. Introduction

It is commonly accepted that very high Deuterium concentration into a Palladium lattice is required to produce Cold Fusion effects as well as extra heat production or nuclear radiation emission. For this reason a standard loading technique has been improved particularly with electrolytic system.

Since three years we have been using this special pulsed electrolytic loading technique testing Palladium plates (25x25x1 mm). Many plates have been tested and an optimization, looking at the loading parameters (absorption rate, overvoltage), has been reached. Indeed, a preliminary study has been performed to observe in which way the status of the electrode surface can modify the absorption dynamics.

(*) All Palladium plates were kindly provided by:
IMRA Material, Japan, which supported partially this work.

The tests show that high loading is not a sufficient condition to produce measurable excess heat.

2. The Experimental Set-Up

The experimental apparatus has been shown in a previous paper⁽¹⁾ and it consists in a flow cooling calorimeter (fig. 1.a) in which there is a special turned Pt wire as anode having inside the Pd plate (fig. 1.b). The cooling system is composed by a double coil, a water bath (17 °C) and a peristaltic pump (flow typically at 1 ml/s). The linearity of the operating range of this calorimeter is from 0.5 up to 150 W (1.5 KW maximum power), depending from the cooling flow from 0.5 to 10 ml/s. The produced electrolytic gases are collected in a close volume (150 cm³) and periodically some electrovalves are open to permit to these gases to go outside quickly. The variation of the pressure is continuously measured and recorded. All physical parameters (time, temperatures, pressure, cell voltage and current, reference voltage of a pseudo R.H.E.) are continuously monitored and acquired by a computer.

The electrolysis is powered by a complex electronics gated system to produce a very high peak current (fig. 2.a). A fast power pulser circuit, triggered by pulse generator, discharges a capacitor to the electrodes of the cell during a selected time (timing): the repetition rate of this discharging process is selectable. During the pulsing a proper circuitry acquires the voltage and current generated. During the discharge, with an integrator circuit, is possible to measure the total electric charge (or the mean current) and the total electric energy (or the mean power) dissipated by the cell. An other proper circuitry, measuring (gate enable) during the inter-pulsing, permit to have the cathode and the floating reference wire voltages: in such a way it is possible to estimate the Tafel over-potential and to understand the difference between Tafel and Volmer region. The circuitry (fig. 2.b) works in 2 stages: firstly the capacitor charges slowly (τ about 10 μ s) from the voltage supply, secondly the fast electronics switch (gated by the trigger pulse) connects the charged capacitor to the cell electrodes, producing a very high current (I_{max} about 150 A) in a short time (from 0.2 to 0.5 μ s). Because the time pulse width (typically less than 1 μ s) is much less than the discharging mean time (τ typically of 7 μ s), in first approximation we can say that, during the pulse, the electrolytic cell is applied to a constant voltage generator (the 2 μ F capacitor having V_{max} about 200 V) so that the electric charge transferred from the capacitor to the cell is around a few percent of the total electric charge cumulated by the capacitor (at maximum of 400 μ C). This pulse can be generated with a repetition rate of 0.5 up to 20 KHz.

3. The Experimental Procedure

Strong motivations lead to use a pulse electrolysis instead of constant current electrolysis:

- It is possible to generate a very high current density value to the cathode (even if in a very short time but taking in account to repeat the pulse at enough high frequency to avoid the deloading process).
- The gaseous recombination (Tafel region) at the cathode is strongly reduced providing a very high loading efficiency (Volmer region) during the first charging up (very low production of gas bubbles permitting to have a very fine measurement of absorbed moles).
- It is possible to measure the cathode voltage during the inter-pulse avoiding the power supply noise (possibility to estimate the over-potential).

- Non-equilibrium conditions are produced at the cathode surface (because of the fast electric field applied to the voltage "double layer" between the electrode and the ionic solution).
- The reproducibility of the loading is guaranteed by the repeatability of the pulse (also is possible to tune up the pulse to have an optimization of the process parameters).

All the plates were tested in these operating conditions: pulse time width about 0.5 μ s (pulse rise time around 100 ns), pulse repetition rate about 5 KHz, peak voltage at 50 V and peak current at 15 A (e.g., mean current is about 60 mA, peak power is 750 W and mean power around 1.5 W). During this pulse the charge transferred is about 13 μ C and the electric energy is around 375 μ J.

Some plates were specially treated by the following procedure: heating to about 700 °C with an oxidizing flame during a processing time of some minutes. After this heat treatment the plates show a thin surface oxide layer (less than 0.5 μ m) having a high chemical resistance to the concentrated nitric acid attack. These plates, after this treatment, are not more supposed to be cold worked.

4. The Deuterium Loading

Some blank tests were performed using the Gold plates of the same size of Pd plates. This test shows a very small Deuterium absorption at the beginning of the charging up (maximum value of absorbed Deuterium is less than $3 \cdot 10^{-3}$ Moles, corresponding at less than 0.05 of D/Au) and vanishing in a few hours (less than 600 C of electrolytic charge). This absorption is explainable by the cell materials (solution, polyethylene, Teflon, heather, etc.). In the calculation we took into account this small effect and made appropriate corrections to the data.

The results for pure "cold worked" Pd plates (I65 and I85) are shown in figures 3.a,b. The absorption rate (fig. 3.a,b left side) must be intended as the amount of Deuterium moles absorbed by Palladium per surface unit and per time unit. The evolution in the time (or electrodes flowed electric charge equivalent) of the absorption is typically decreasing closing to the zero in a few days (roughly 5 days or 25000 C equivalent). The D/Pd loading ratio (fig. 3.a,b right side), at the saturation, reaches values around 1 or more (the cumulative experimental errors are roughly $\pm 10\%$). The very similar absorption shapes show that this process can be enough reproducible.

The results for oxidized surface Pd plates (I63 and I340) are shown in figures 4.a,b; also in this case the absorption shapes and the D/Pd curves are very similar indicating a good reproducible grade. It is clear, comparing to the previous figures, that the absorption dynamics at the beginning of the charging up is quite different: the absorption is roughly flat for long time (5000 C or about 1 day) for both the plates. It means that the PdO surface layer has modified the absorption process in such a way that the ingoing Deuterium does not see an increased concentration during the time of this anomalous process. Obviously, when the plate reaches an high concentration of Deuterium the absorption drops down in a faster way to slowly vanishing at saturation level.

Some Pd alloys has been tested to better understand the role that some other different metals (sometimes present as impurities) can play in these absorption processes. A PdAg (90% / 10%) alloy has been used (fig. 5.a: I120 plate). The behavior of this plate is not different in respect to the pure Pd shown if we take in account that the useful Pd material is reduced by 10% of the total plate: Silver is known to be not a Deuterium absorption material, but it increases the hardness of the Pd plate. This PdAg plate has been surface oxidized according to the standard procedure and his behavior is shown in figure 5.b (I118 plate): the high value shoulder of absorption rate

is still present but the D/Pd ratio does not increase (because the high Ag percent in this alloy).

Also a PdCe (99.9% + 0.1%) alloy has been used (fig. 6.a: I418 plate). It is known that the element Ce (Cerium) is a strong Hydrogen absorption inhibitor (even at low concentration) as is visible in the previous figure of D/PdCe. It is evident that the oxidized PdCe surface increases the loading ratio (fig. 6.b: I419 plate), moreover the typical oxidization shoulder is visible at the absorption rate.

Also a PdY (99% + 1%) alloy has been used (fig. 7.a: I613 plate). The Y (Yttrium) is a good Hydrogen absorption element (as well some rare earth) and the loading ratio is quite high but not much higher than pure Pd plates results. Still the PdY oxidized surface shows the "oxidation effect" looking at the absorption rate (fig. 7.b: I614 plate) and the loading ratio does not appear to be increased by this treatment (however it is still higher than 1). In this case the presence of Y does not help the plate to overcome the loading respect to the pure Pd plate.

5. Excess Heat Results

As reported⁽²⁾, it seems to be a strong correlation respect to the oxidized surface and an increasing of excess heat appearing during the flat high absorption rate at beginning of the loading (fig. 8.b,c: plates I63 and I340). In similar condition we did not detect a similar effect using a pure Pd plate (fig. 8.a: plate I65). In such a way, the surface dynamic seems to play an important role for the excess heat increasing. The alloys tested did not show similar effects even if we have to say that we operated at a few watts of input power (roughly 1.5 W), too close at the lower operating limit range of the calorimeter (about 0.5 W).

Conclusion

We can remark that pulsed electrolysis (at very high peak current) can be a "sufficient" condition to over-load Pd Plates: in this condition the plate metallurgy is not a constrain anymore.

Pd alloys are not necessary to have Pd overloading (in particular if pulse electrolysis is used) and it seems advisable to use just Pd.

Pd treated surface (as well as oxidized surface) strongly modifies the absorption dynamic influencing the loading parameter; furthermore it seems to involve particular dynamic to increase the heat production. We can say that the absorption rate seems to be more indicative parameter concerning the D/Pd ratio.

Finally, a bulk condition to generate excess heat is not a necessary condition, and surface dynamic can be a more important condition to realize heat production.

References

1. F.Celani, A.Spallone, P.Tripodi et al. "High power μ s pulsed electrolysis for large deuterium loading on Pd plates."
Transactions of Fusion Technology, Vol. 26, Dec. 1994, pg. 127-137.
2. F.Celani, A.Spallone, P.Tripodi et al. "Reproducible D/Pd ratio over 1 and excess heat correlation by μ s pulse high current electrolysis."
Publishing on Fusion Technology, summer 1995.

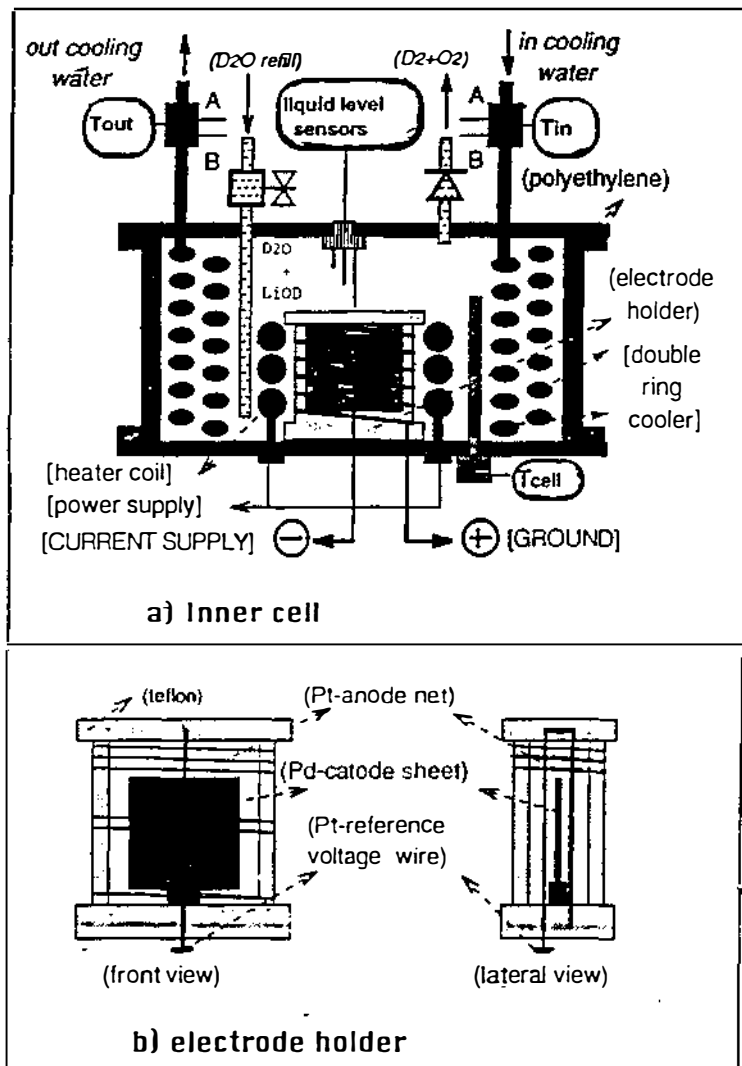

Fig. 1 - Inner cell design and electrode holder.

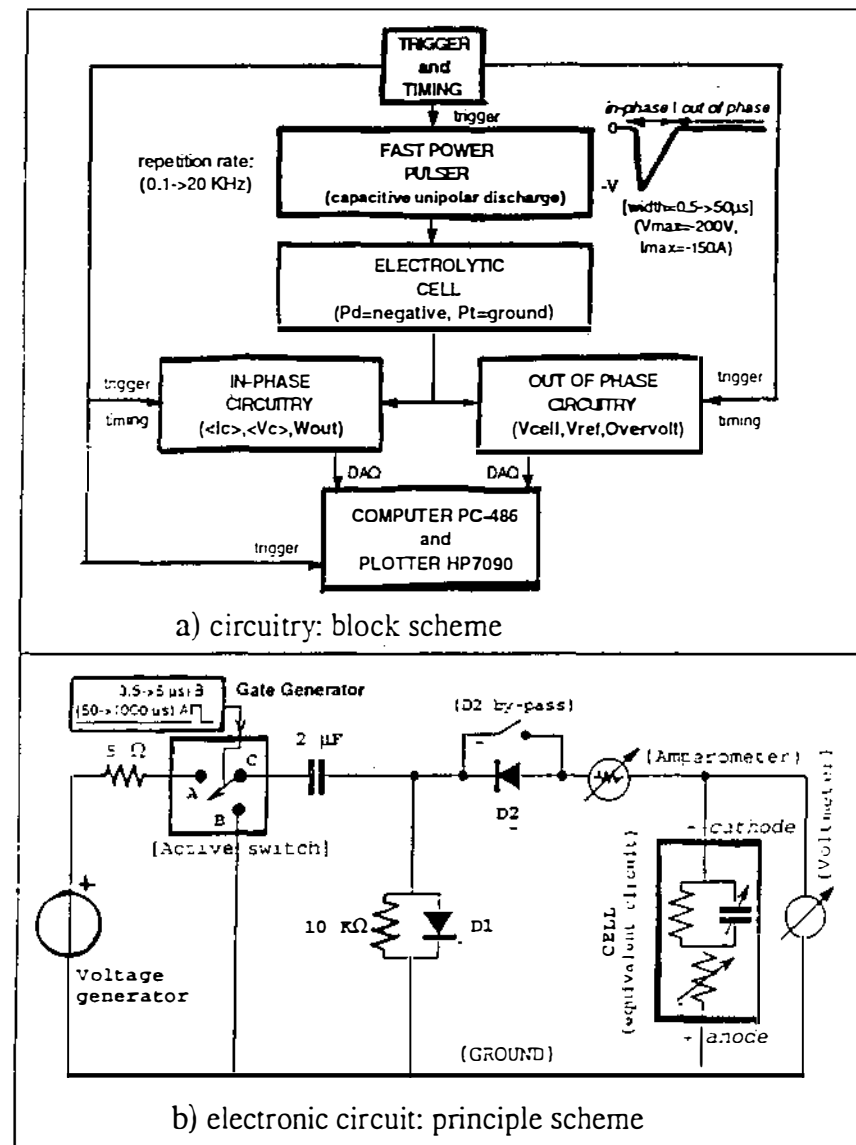

Fig. 2 - High power pulse circuitry.

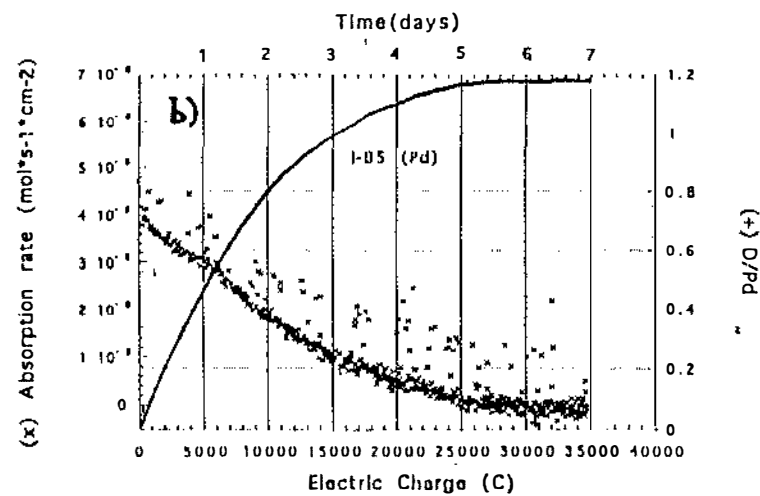
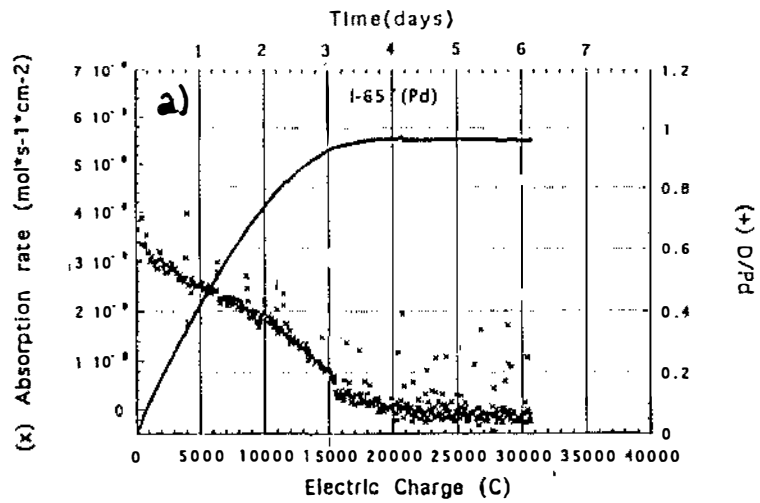

Fig. 3 - Pure palladium (no surface treatment)
 a) Plate I-65
 b) Plate I-85

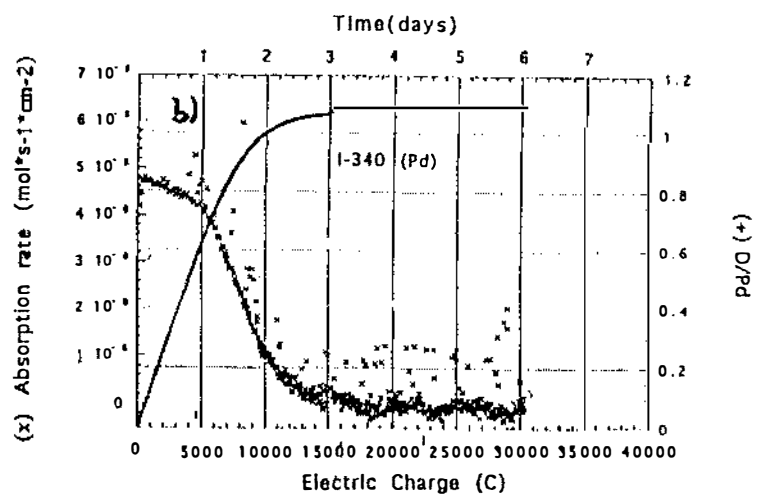
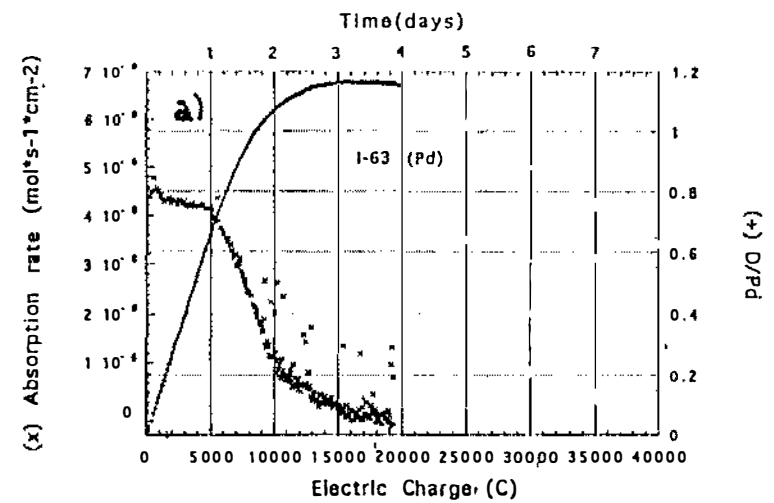

Fig. 4 - Pure palladium (oxidized surface)
 a) Plate I-63
 b) Plate I-340

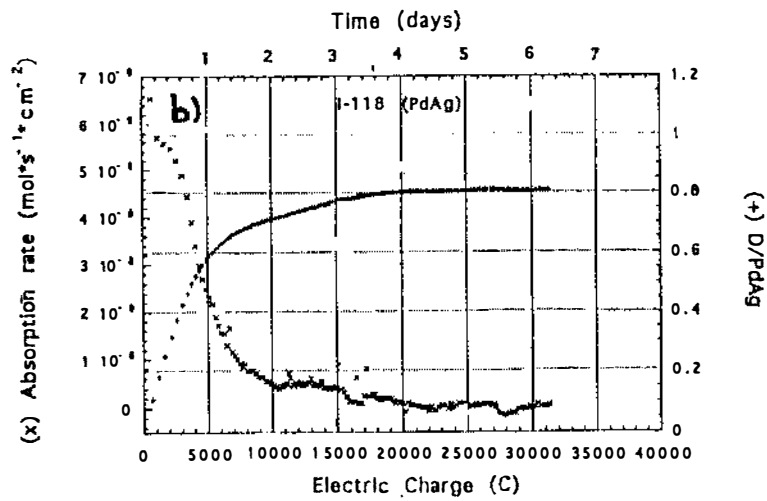
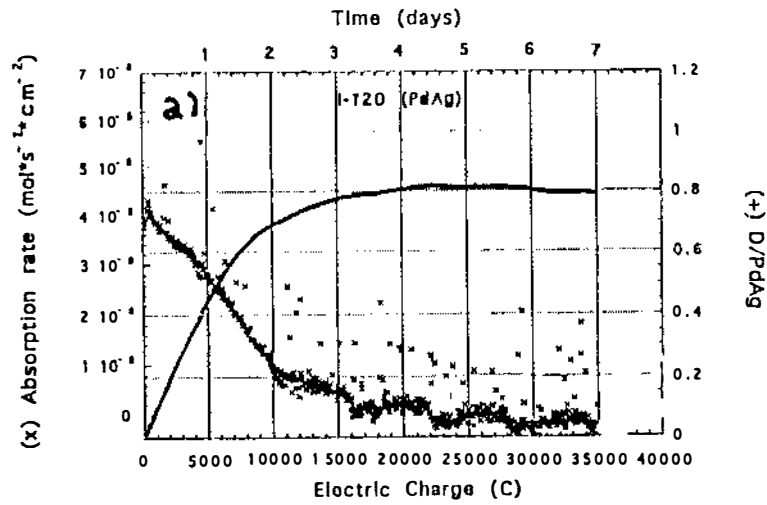

Fig. 5 - Palladium Silver alloy
 a) Plate I-120 (no surface treatment)
 b) Plate I-118 (oxidized surface)

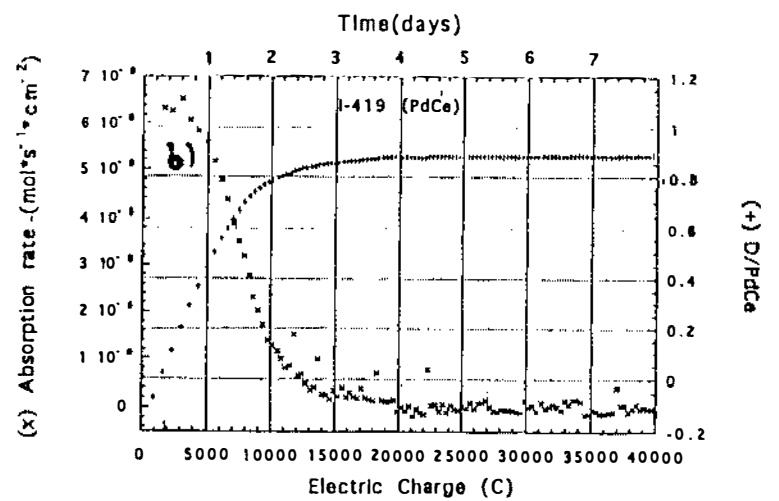
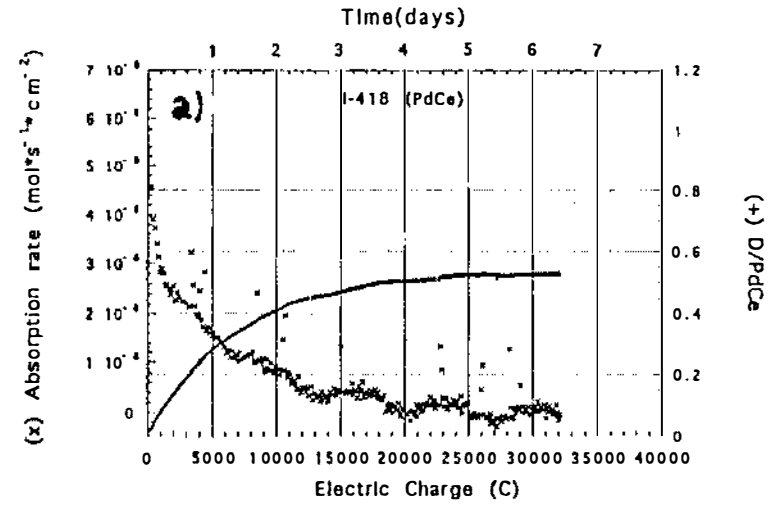

Fig. 6 - Palladium Cerium alloy
 a) Plate I-418 (no surface treatment)
 b) Plate I-419 (oxidized surface)

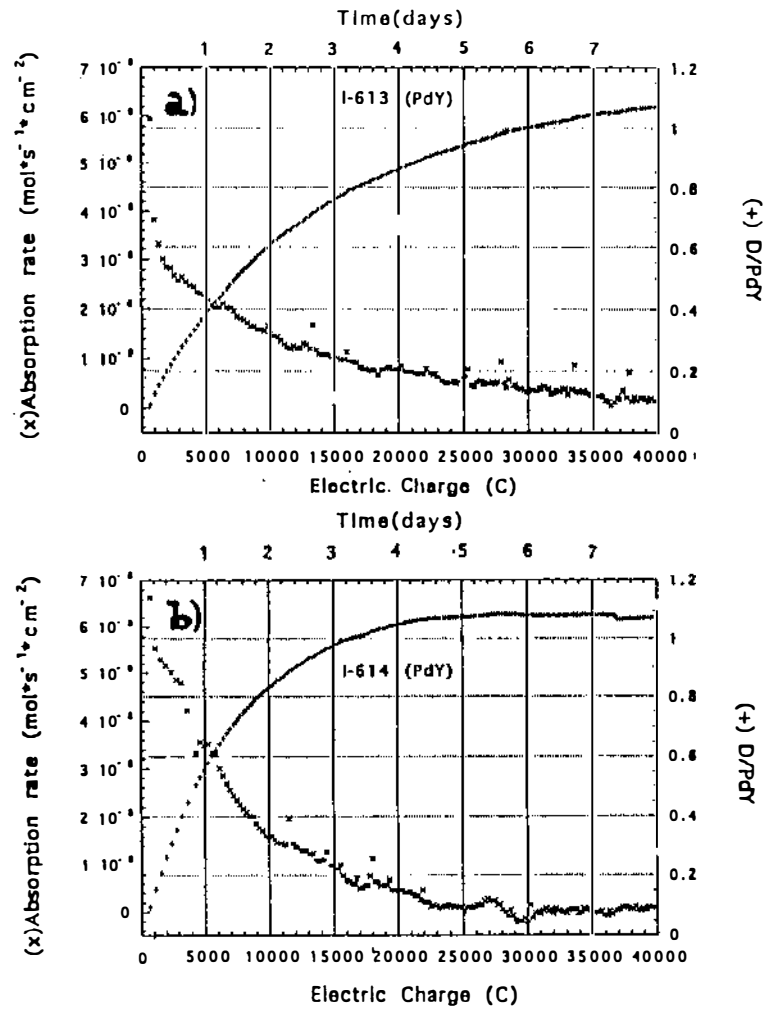

Fig. 7 - Palladium Yttrium alloy
 a) Plate I-613 (no surface treatment)
 b) Plate I-614 (oxidized surface)

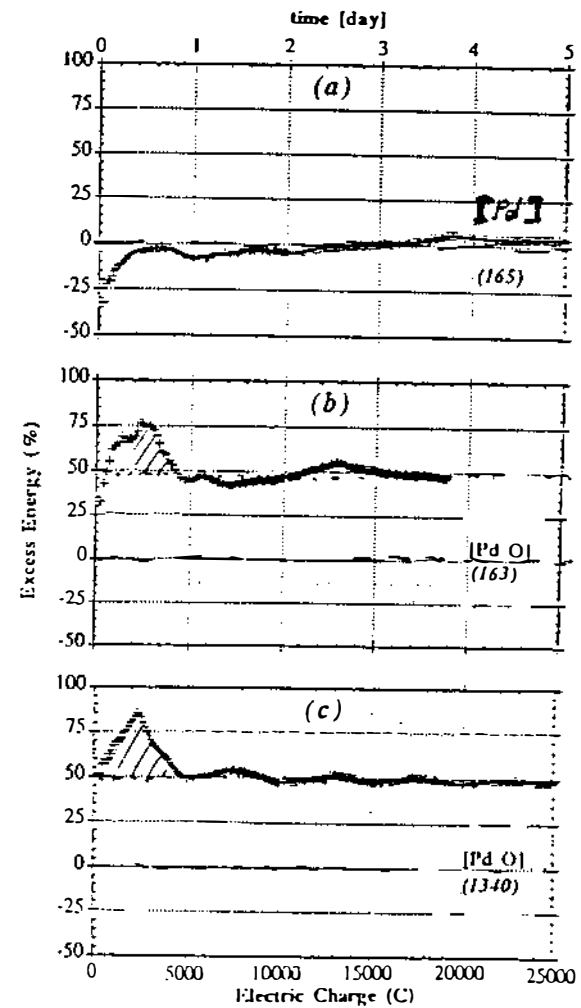

Fig. 8 Pd plates: Excess energy variation (%) vs time and electric charge. All data refer to the Au controls.